

How to use FEMTIC

1. Serial calculation

- 1) Copy all input files to a work directory.
- 2) Write '1' below 'NUM_THREADS' in 'control.dat'.
- 3) In the work directory, execute the following command.

femtic

2. Parallel calculation only using MPI

- 1) Copy all input files to a work directory.
- 2) Write '1' below 'NUM_THREADS' in 'control.dat'.
- 3) In the work directory, execute the following command.

mpiexec -n [Number of MPI processes] femtic

3. Parallel calculation only using OpenMP

- 1) Copy all input files to a work directory.
- 2) Write number of threads below 'NUM_THREADS' in 'control.dat'.
< Example >
NUM_THREADS
4
- 3) In the work directory, execute the following command.

femtic

4. Hybrid MPI/OpenMP parallel calculation

- 1) Copy all input files to a work directory.
- 2) Write number of threads below 'NUM_THREADS' in 'control.dat'.
< Example >
NUM_THREADS
4
- 1) In the work directory, execute the following command.

mpiexec -n [Number of MPI processes] femtic

OpenMP-MPI hybrid parallelization

OpenMP-MPI Hybrid parallelization speed up the forward and inversion calculation.

Each process treats different frequencies

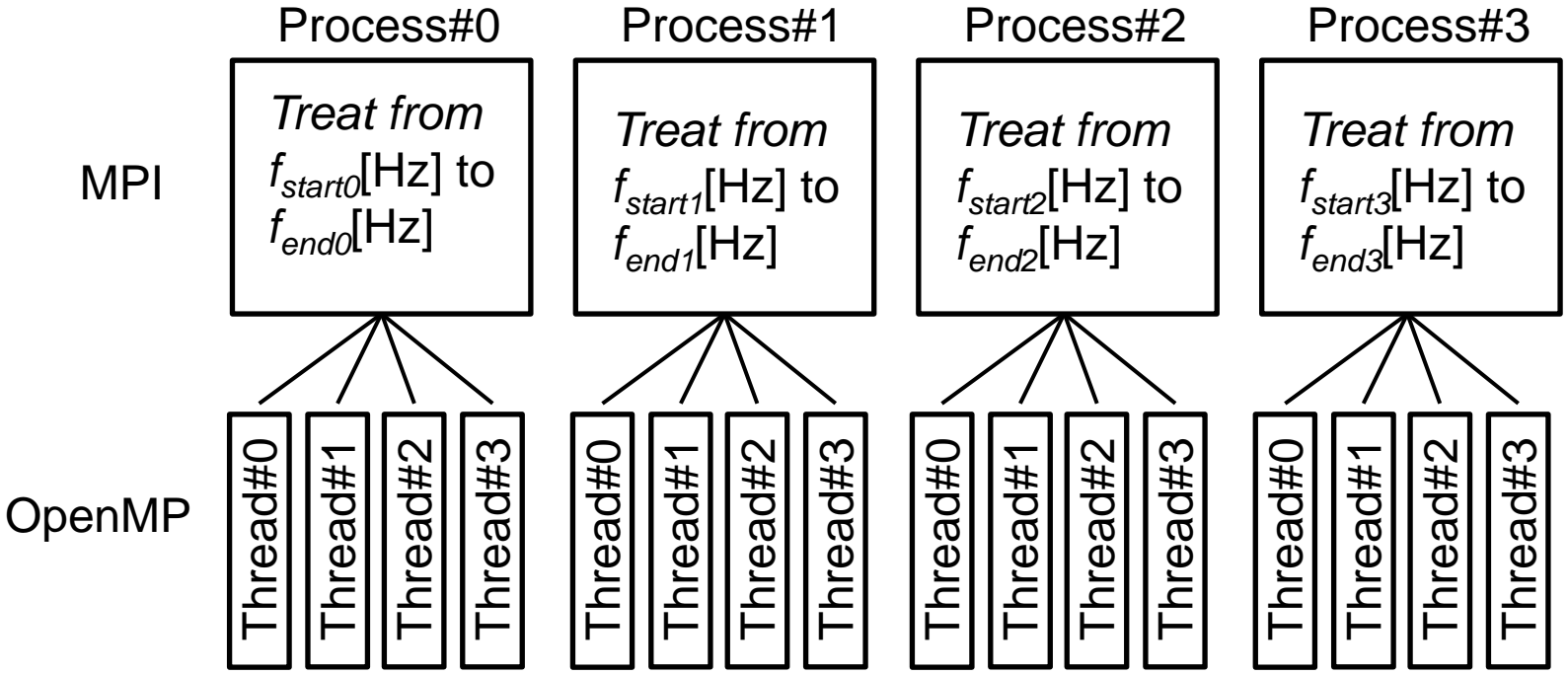

Following procedure are performed with multi-thread
Making roughening matrix, Making coefficient matrix
Making sensitivity matrix, etc

Input files

File name	Content
control.dat	Parameters controlling FEMTIC
mesh.dat	Data of computational mesh
resistivity_block_iter[Iter#].dat	Data of parameter cells and initial resistivity values
observe.dat	Observation data
distortion_iter[Iter#].dat	Initial parameters of galvanic distortion

In the file names, [Iter#] indicates the start number of the iteration.

The start number of the iteration can be specified in 'ITERATION' data in 'control.dat'.

File format of control.dat (1/9)

This file contains the parameters controlling FEMTIC.

Keyword	Content	Data type	Option	Default	Example
MESH_TYPE	Type of element	Integer (0 or 1)	0: Brick hexahedral element 1: Tetrahedral element 2: Deformed non-conforming hexahedral element	0	MESH_TYPE 1
INV_METHOD	Type of inversion method	Integer (0 or 1)	0: Model space method 1: Data space method	0	INV_METHOD 0
DATA_SPACE_METHOD	Type of data-space method	Integer (1 or 2)	1: Inverse of roughening matrix R is used in the data-space method 2: Inverse of $R^T R$ matrix is used in data-space method	1	DATA_SPACE_METHOD 1
NUM_THREADS	Number of threads	Integer greater than or equal to 1		1	NUM_THREADS 4
FWD_SOLVER	Mode of direct sparse solver ^{*1)}	Integer (0, 1 or 2)	0: In-core mode 1: Out-of-core mode is selected when the amount of the memory required by the direct solver is larger than that specified below 'MEM_LIMIT'; otherwise in-core mode is selected. 2: Out-of-core mode.	0	FWD_SOLVER 0

*1) In the in-core mode, all information required by the direct solver is stored in memory. On the other hand, in the out-of-core mode, some of the information are stored to and read from temporary data files at hard disk. Computational speed of the in-core mode is much higher than that of the out-of-core mode. However, the in-core mode requires much more memory than the out-of-core mode.

Type of element

1. Brick hexahedral element

Topography/bathymetry cannot be incorporated.

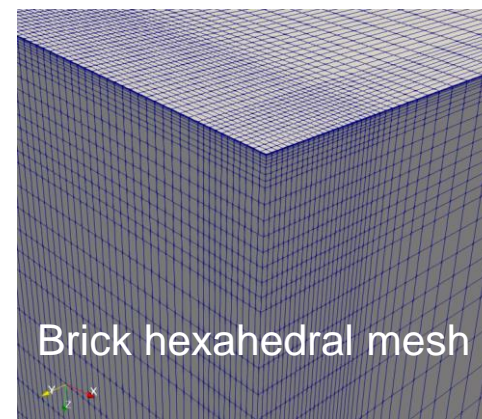

Brick hexahedral mesh

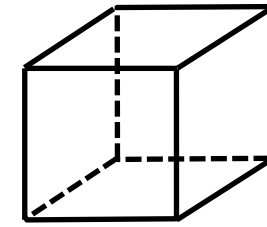

Brick hexahedral element

2. Tetrahedral element

3. Non-conforming deformed hexahedral mesh

Discretization method of non-conforming deformed hexahedral mesh is based on that of Grayver & Burg (2014).

In FEMTIC, the division number of one side can be double compared to the other side only in the horizontal direction.

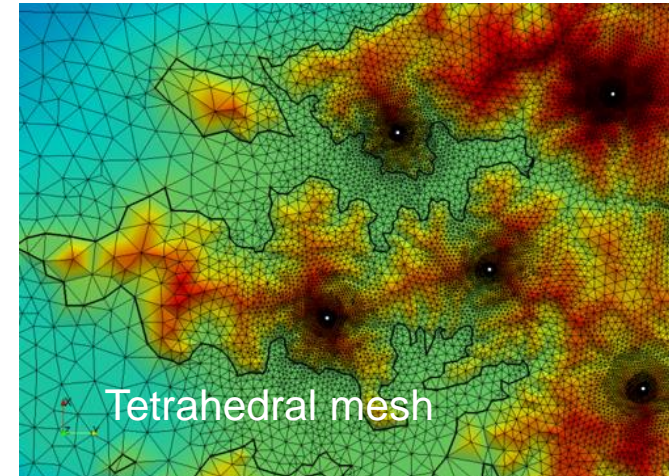

Tetrahedral mesh

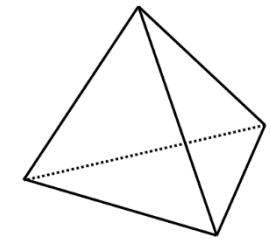

Tetrahedral element

Grayver, a. V., & Burg, M. (2014). *Robust and scalable 3-D geo-electromagnetic modelling approach using the finite element method. Geophysical Journal International.*
<https://doi.org/10.1093/gji/ggu119>

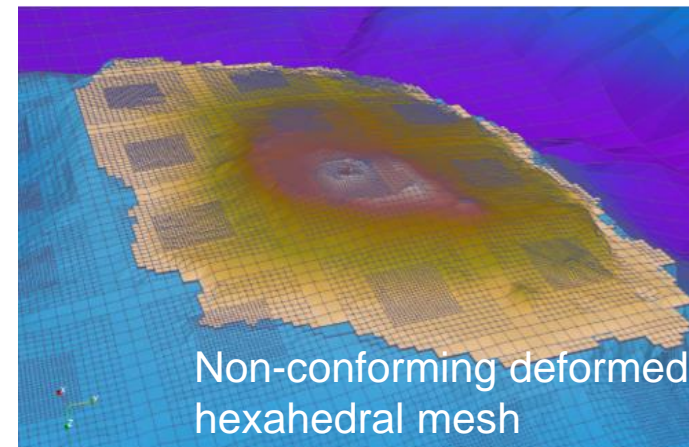

Non-conforming deformed hexahedral mesh

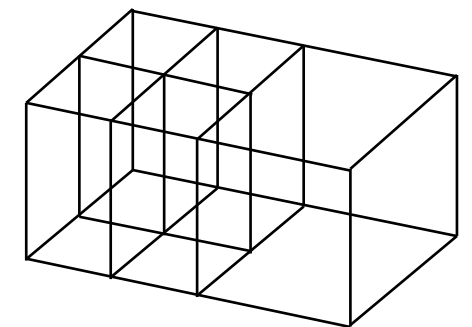

Non-conforming deformed hexahedral element

File format of control.dat (2/9)

Keyword	Content	Data type	Option	Default	Example
MEM_LIMIT	The maximum amount of memory (in MB) for direct sparse solver	Real number greater than 0		3000(MB)	MEM_LIMIT 3000
DIV_NUM_RHS_FWD	Division number of the right-hand-side vectors of the linear equation solved for the calculation of sensitivity matrix *1)	Integer greater than or equal to 1		1	DIV_NUM_RHS_FWD 1
DIV_NUM_RHS_INV	Division number of the right-hand-side vectors of the linear equation solved for the calculation of the updates of model parameters. This option is used only when the data-space method is selected *2)	Integer greater than or equal to 1		1	DIV_NUM_RHS_INV 1

*1) In calculating sensitivity matrix, a linear equation with multiple right-hand-sides is solved. When division number of the right-hand-side vectors is one, a routine of PARDISO is called one time to solve the linear equation. On the other hand, when the division number is more than one, that routine is called the specified times and the number of right-hand-side vectors at each time is inversely proportional to the division number as shown in the next slide. In general, the smaller the division number becomes, the faster the speed for solving a linear equation becomes. However, the smaller the division number is, the more memory is required.

*2) When the data-space method is used, a linear equation with multiple right-hand-sides is solved for the calculation of the updates of model parameters. When division number of the right-hand-side vectors is one, a routine of PARDISO is called one time to solve the linear equation. On the other hand, when the division number is more than one, that routine is called the specified times and the number of right-hand-side vectors at each time is inversely proportional to the division number as shown in the next slide. In general, the smaller the division number becomes, the faster the speed for solving a linear equation becomes. However, the smaller the division number is, the more memory is required.

Linear equation to be solved

$$\begin{bmatrix} \mathbf{A} \end{bmatrix} \begin{bmatrix} x_1 & x_2 & x_3 & x_4 & x_5 & x_6 & x_7 & x_8 \end{bmatrix} = \begin{bmatrix} b_1 & b_2 & b_3 & b_4 & b_5 & b_6 & b_7 & b_8 \end{bmatrix}$$

(1) Division number of the right-hand-side vectors is one

(2) Division number of the right-hand-side vectors is two

Thread #0

Thread #1

Thread #0

Thread #1

$$\begin{bmatrix} \mathbf{A} \end{bmatrix} \begin{bmatrix} x_1 & x_2 & x_3 & x_4 \end{bmatrix} = \begin{bmatrix} b_1 & b_2 & b_3 & b_4 \end{bmatrix}$$

$$\begin{bmatrix} \mathbf{A} \end{bmatrix} \begin{bmatrix} x_5 & x_6 & x_7 & x_8 \end{bmatrix} = \begin{bmatrix} b_5 & b_6 & b_7 & b_8 \end{bmatrix}$$

$$\begin{bmatrix} \mathbf{A} \end{bmatrix} \begin{bmatrix} x_1 & x_2 \end{bmatrix} = \begin{bmatrix} b_1 & b_2 \end{bmatrix}$$

$$\begin{bmatrix} \mathbf{A} \end{bmatrix} \begin{bmatrix} x_3 & x_4 \end{bmatrix} = \begin{bmatrix} b_3 & b_4 \end{bmatrix}$$

A routine of PARDISO is called again



Thread #0

Thread #1

$$\begin{bmatrix} \mathbf{A} \end{bmatrix} \begin{bmatrix} x_5 & x_6 \end{bmatrix} = \begin{bmatrix} b_5 & b_6 \end{bmatrix}$$

$$\begin{bmatrix} \mathbf{A} \end{bmatrix} \begin{bmatrix} x_7 & x_8 \end{bmatrix} = \begin{bmatrix} b_7 & b_8 \end{bmatrix}$$

File format of control.dat (3/9)

Keyword	Content	Data type	Option	Default	Example
ELEC_FIELD	Type of the electric field used to calculate response functions	Integer (0, 1 or -1)	0: Horizontal electric field 1: Tangential electric field -1: Type of the electric field of each station is individually selected *2)	0	ELEC_FIELD 0
OWNER_ELEMENT	Type of owner element *1) of observation stations	Integer (0, 1 or -1)	0: Downward element 1: Upward element -1: Type of owner element of each station is individually selected *2)	0	OWNER_ELEMENT 0
RESISTIVITY_BOUNDS	Type of the method limiting subsurface resistivity to be estimated	Integer (0 or 1)	0: When a resistivity value is exceeds the upper limit or become less than the lower limit, the resistivity value is forced to be the upper limit or the lower limit, respectively. 1: The method proposed by Kim and Kim (2010) *3) is used.	0	RESISTIVITY_BOUNDS 0

*1) Owner element denotes the element in which the electric field and magnetic field of the observation station are interpolated.

*2) When this option is selected, you need to specify the type of the electric field and/or the owner element for each station in 'observe.dat'.

*3) The method is described in detail in the next slide.

$$x = \frac{1}{n} \ln \left(\frac{m - m_{min}}{m_{max} - m} \right)$$

$$m = \log_{10}(\rho)$$

ρ : Resistivity (Ωm)

$$m_{min} = \log_{10}(\rho_{min})$$

ρ_{min} : Lower limit of resistivity (Ωm)

$$m_{max} = \log_{10}(\rho_{max})$$

ρ_{max} : Upper limit of resistivity (Ωm)

In the method proposed by Kim and Kim (2010), the range of resistivity is constrained by the above equation and parameter x .

Updates of parameter x (δx) is calculated by the following equation from the update of the common logarithm of resistivity (δm).

$$\delta x = \frac{\partial x}{\partial m} \delta m = \frac{m_{max} - m_{min}}{n(m_{max} - m)(m - m_{min})} \delta m$$

Next, the new resistivity is calculated from the previous values of x (x_{pre}) and δx by the equation below.

$$\rho = 10^m$$

$$m = \frac{m_{max} - m_{min}}{2} \tanh \left(\frac{nx}{2} \right) + \frac{m_{min} + m_{max}}{2} = \frac{m_{max} - m_{min}}{2} \tanh \left(\frac{n(x_{pre} + \delta x)}{2} \right) + \frac{m_{min} + m_{max}}{2}$$

File format of control.dat (4/9)

Keyword	Content	Data type	Option	Default	Example
SMALL_VALUE	A small positive value used to regularize roughening matrix (Usui et al., 2017). This option is necessary only when the data-space method is selected.	Positive real number			SMALL_VALUE 1.0e-4
OUTPUT_PARAM	Number of output variables	Integer greater than or equal to 0			OUTPUT_PARAM 2 0 4
	Output variables for the visualization with ParaView ^{*1)}	Integer(s)			
OFFILE_TYPE	Format of output file for ParaView	Integer (0 or 1)	0: VTK file format (ASCII) 1: Ensight Gold file format (binary)	1	OFFILE_TYPE 1
MOVE_OBS_LOC	When you write this keyword, observation station is forced to be located at the center of the element face				MOVE_OBS_LOC

*1) Detail of this option is described in the next slide.

Format about the keyword 'OUTPUT_PARAM'

Under the keyword, you write the number of output variables first.

Following the number, you need to write the index numbers of the variables needed.

The variables you selected are outputted by VTK file format (ASCII) or Enight Gold file format (binary) depending on the setting of 'OFFILE_TYPE'.

The output files can be read and visualized by ParaView.

<Example>

By the following setting, the resistivity and sensitivity are only outputted.

```
OUTPUT_PARAM  
2  
0 4
```

Output file names of Enight Gold file format

Index	Variable type	Output file name
0	Resistivity	Resistivity.iter[Iter#]
1	Electric field	ReE_Freq[Freq#]_ExPol.iter[Iter#] ImE_Freq[Freq#]_ExPol.iter[Iter#] ReE_Freq[Freq#]_EyPol.iter[Iter#] ImE_Freq[Freq#]_EyPol.iter[Iter#]
2	Magnetic field	ReH_Freq[Freq#]_ExPol.iter[Iter#] ImH_Freq[Freq#]_ExPol.iter[Iter#] ReH_Freq[Freq#]_EyPol.iter[Iter#] ImH_Freq[Freq#]_EyPol.iter[Iter#]
3	Electric current	Rej_Freq[Freq#]_ExPol.iter[Iter#] Imj_Freq[Freq#]_ExPol.iter[Iter#] Rej_Freq[Freq#]_EyPol.iter[Iter#] Imj_Freq[Freq#]_EyPol.iter[Iter#]
4	Sensitivity	Sensitivity.iter[Iter#] NormalizedSensitivity.iter[Iter#]
5	Sensitivity density	SensitivityDensity.iter[Iter#] NormalizedSensitivityDensity.iter[Iter#]

*1) When you select VTK file format (ASCII) as output file format, output variables are written in the files named as 'result_[PE#]_iter[Iter#].vtk'.

*2) In the file names, [PE#] and [Iter#] indicate process number and iteration number, respectively.

File format of control.dat (5/9)

Keyword	Content	Data type	Option	Default	Example
DISTORTION	Treatment of galvanic distortion	Integer (0, 1, 2 or 3)	0: Distortion matrix is not estimated 1: Differences of distortion matrix and unit matrix are estimated. 2: Both gains and rotations are estimated* ¹). 3: Only gains are estimated.	None. You must write this keyword and an option.	DISTORTION 1
TRADE_OFF_PARAM	Trade-off parameters	Real positive value(s)	The number of option(s) depends on the option of the keyword 'DISTORTION'. If the option of 'DISTORTION' is '0', you should write only trade-off parameter α . If the option of 'DISTORTION' is '1' or '3', you should write trade-off parameters α and β . If the option of 'DISTORTION' is '2', you should write trade-off parameters α , β_1 and β_2 .	None. You must write this keyword and option(s).	TRADE_OFF_PARAM 1.0 0.1
ITERATION	Start and end iteration number	Two integers greater than or equal to 0	Start and end iteration number	None. You must write this keyword and options.	ITERATION 0 10
CONVERGE	Convergence threshold (%) of Gauss-Newton iteration	Real value greater than 0	If the change rates of the objective function and its respective terms of the current iteration from those of the previous iteration are less than the threshold value, the Gauss-Newton iteration is finished.	1.0	CONVERGE 1.0

*1) Distortion matrix is decomposed as Smith (1995)

Smith, J. T. (1995). Understanding telluric distortion matrices. *Geophysical Journal International*, 122(1), 219–226. <https://doi.org/10.1111/j.1365-246X.1995.tb03549.x>

Objective function

The form of objective function depends on the setting of 'DISTORTION'.

0: Distortion matrix is not estimated

$$\phi(\mathbf{m}) = \phi_d(\mathbf{m}) + \alpha^2 \phi_m(\mathbf{m})$$

$\phi_d(\mathbf{m})$: Data misfit

$\phi_m(\mathbf{m})$: Model roughness

α : Trade-off parameter

1: Differences of distortion matrix \mathbf{C} and unit matrix are estimated

$$\phi(\mathbf{m}) = \phi_d(\mathbf{m}) + \alpha^2 \phi_m(\mathbf{m}) + \beta^2 \phi_c(\mathbf{m})$$

$\phi_d(\mathbf{m})$: Data misfit, $\phi_m(\mathbf{m})$: Model roughness

$$\phi_c(\mathbf{m}) = \sum_{i=1}^{\#sites} [|c'_{xx}|^2 + |c'_{xy}|^2 + |c'_{yx}|^2 + |c'_{yy}|^2]$$

α, β : Trade-off parameter

$$\mathbf{C}' = \mathbf{C} - \mathbf{I} = \begin{pmatrix} c_{xx} & c_{xy} \\ c_{yx} & c_{yy} \end{pmatrix} - \begin{pmatrix} 1 & 0 \\ 0 & 1 \end{pmatrix} = \begin{pmatrix} c'_{xx} & c'_{xy} \\ c'_{yx} & c'_{yy} \end{pmatrix}$$

2: Both gains and rotations are estimated

$$\phi(\mathbf{m}) = \phi_d(\mathbf{m}) + \alpha^2 \phi_m(\mathbf{m}) + \beta_1^2 \phi_{c1}(\mathbf{m}) + \beta_2^2 \phi_{c2}(\mathbf{m})$$

$\phi_d(\mathbf{m})$: Data misfit, $\phi_m(\mathbf{m})$: Model roughness

$$\phi_{c1}(\mathbf{m}) = \sum_{i=1}^{\#site} [G_x^2 + G_y^2], \phi_{c2}(\mathbf{m}) = \sum_{i=1}^{\#site} [\beta_x^2 + \beta_y^2]$$

α, β_1, β_2 : Trade-off parameter

$$\mathbf{C} = \begin{pmatrix} 10^{G_x} \begin{pmatrix} \cos \beta_x \\ \sin \beta_x \end{pmatrix} & 10^{G_y} \begin{pmatrix} -\sin \beta_y \\ \cos \beta_y \end{pmatrix} \end{pmatrix}$$

3: Only gains are estimated.

$$\phi(\mathbf{m}) = \phi_d(\mathbf{m}) + \alpha^2 \phi_m(\mathbf{m}) + \beta^2 \phi_c(\mathbf{m})$$

$\phi_d(\mathbf{m})$: Data misfit, $\phi_m(\mathbf{m})$: Model roughness

$$\phi_c(\mathbf{m}) = \sum_{i=1}^{\#site} [G_x^2 + G_y^2]$$

α, β : Trade-off parameter

$$\mathbf{C} = \begin{pmatrix} 10^{G_x} & 0 \\ 0 & 10^{G_y} \end{pmatrix}$$

File format of control.dat (6/9)

Keyword	Content	Data type	Option	Default	Example
ROUGH_MATRIX	Way of making roughening matrix ¹⁾	Integer (0, 1, 2 or -1)	0: Based on element 1: Based on parameter cell 2: Based on element (with weights based on area-volume ratio) -1: From external file 'roughening_matrix.dat' ²⁾	0	ROUGH_MATRIX 0
OUTPUT_ROUGH_MATRIX	Output roughening matrix as an external file ²⁾ 'roughening_matrix.out'				OUTPUT_ROUGH_MATRIX
BOTTOM_RESISTIVITY	Give a resistivity below the bottom of mesh. By using this option, roughening matrix R will be regularized and then data-space inversion is stabilized	Positive real value			BOTTOM_RESISTIVITY 10.0

*1) Detail of this option is described in the next slides.

*2) Format of this file is explained in the later slides.

Way of making roughening matrix (1/2)

(1) Based on parameter cell

Roughening matrix is a Laplacian filter based on the relation of parameter cells

	Column corresponding to parameter cell 1	Column corresponding to parameter cell 2
Row corresponding to parameter cell 1	1	-1
Row corresponding to parameter cell 2	-1	1

$$R = \begin{pmatrix} 1 & -1 \\ -1 & 1 \end{pmatrix}$$

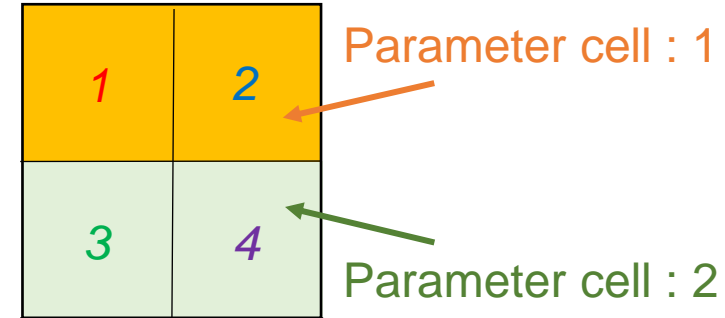

In this figure, different colors indicate different parameter cells and italic numbers indicate element numbers. For simplified explanation, in this example, 2-D structure is treated.

(2) Based on element

* Because elements 1 and 2 (3 and 4) belong to parameter cell, differentiation between the two elements is not considered.

	Column corresponding to element 1	Column corresponding to element 2	Column corresponding to element 3	Column corresponding to element 4
Row corresponding to element 1	1	0	-1	0
Row corresponding to element 2	0	1	0	-1
Row corresponding to element 3	-1	0	1	0
Row corresponding to element 4	0	-1	0	1



Components of roughening matrix are calculated from the components of the roughening matrix based on the relation of elements

	Column corresponding to parameter cell 1	Column corresponding to parameter cell 2
Row corresponding to parameter cell 1	2	-2
Row corresponding to parameter cell 2	-2	2

$$R = \begin{pmatrix} 2 & -2 \\ -2 & 2 \end{pmatrix}$$

Way of making roughening matrix (2/2)

(3) Based on element (with weights based on area-volume ratio)

	Column corresponding to parameter cell 1	Column corresponding to parameter cell 2	Column corresponding to parameter cell 3	Column corresponding to parameter cell 4
Row corresponding to parameter cell 1	$\frac{S_{1,2} + S_{1,3}}{V_1}$	$-\frac{S_{1,2}}{V_1}$	$-\frac{S_{1,3}}{V_1}$	0
Row corresponding to parameter cell 2	$-\frac{S_{2,1}}{V_2}$	$\frac{S_{2,1} + S_{2,4}}{V_2}$	0	$-\frac{S_{2,4}}{V_2}$
Row corresponding to parameter cell 3	$-\frac{S_{3,1}}{V_3}$	0	$\frac{S_{3,1} + S_{3,4}}{V_3}$	$-\frac{S_{3,4}}{V_3}$
Row corresponding to parameter cell 4	0	$-\frac{S_{4,2}}{V_4}$	$-\frac{S_{4,3}}{V_4}$	$\frac{S_{4,2} + S_{4,3}}{V_4}$

R =

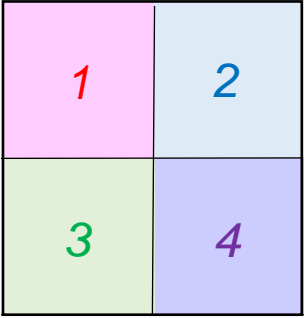

In this figure, different colors indicate different parameter cells and italic numbers indicate element numbers.

For simplified explanation, in this example, 2-D structure is treated.

In this example, respective elements have respective different parameter cells.

V_X indicates the volume of element X.

$S_{X,Y}$ indicates the area of the face shared by element X and Y.

Format of 'roughening_matrix.out' and 'roughening_matrix.dat'

Example

	Column corresponding to parameter cell 1	Column corresponding to parameter cell 2	Column corresponding to parameter cell 3
Row corresponding to parameter cell 1	1	-0.5	-0.5
Row corresponding to parameter cell 2	-1	2	-1
Row corresponding to parameter cell 3	0	-1	1

$R = \begin{pmatrix} 1 & -0.5 & -0.5 \\ -1 & 2 & -1 \\ 0 & -1 & 1 \end{pmatrix}$



```

4↓ ← Total number of parameter cells
0↓ ← Parameter cell 0 (It must be air layer)
0↓ ← Numbers of non-zero columns for parameter cell 0
Parameter cell 1 → 1↓
Numbers of non-zero columns for parameter cell 1 → 3
Non-zero components for parameter cell 1 → 1.000000e+000  -5.000000e-001  -5.000000e-001↓
Parameter cell 2 → 2↓
Numbers of non-zero columns for parameter cell 2 → 3
Non-zero components for parameter cell 2 → -1.000000e+000  2.000000e+000  -1.000000e+000↓
Parameter cell 3 → 3↓
Numbers of non-zero columns for parameter cell 3 → 2
Non-zero components for parameter cell 3 → -1.000000e+000  1.000000e+000↓
    
```

File format of control.dat (7/9)

Keyword	Content	Data type	Option	Default	Example
DIFF_FILTER	Type of norm	Integer (1 or 2)			DIFF_FILTER 1 0.01 1 5 10
	$\varepsilon_1, \varepsilon_2$	Positive real values			
	Maximum iteration number of iteratively reweighted least-squares algorithm	Positive real value			
	Convergence threshold (%) of IRLS algorithm	Real value greater than 0			

- ✓ If this option is used, difference filter is used for roughening matrix instead of Laplacian filter.
- ✓ L_1 norm can be used in addition to L_2 norm.
- ✓ When L_1 norm is selected, iteratively reweighted least-squares (IRLS) algorithm (Farquharson & Oldenburg, 1998) is used within the model update phase.
- ✓ Weight w multiplied to the roughening matrix (difference filter) is

$$w = \sqrt{0.5/d}$$

$$d = \min(\max(\varepsilon_1, |\log_{10}(\rho) - \log_{10}(\rho_{neib})|), \varepsilon_2)$$

- ✓ IRLS is stopped when the iteration number reaches the specified maximum value or change rate of the model roughness is less than the convergence threshold.
- ✓ To use this option, you need to select the data-space method, and the inverse of RTR matrix is used in the data-space method.

Example of difference filter with L_2 norm

```
INV_METHOD
1
DATA_SPACE_METHOD
2
DIFF_FILTER
2
0.01 2
1
1
```

Example of difference filter with L_1 norm

```
INV_METHOD
1
DATA_SPACE_METHOD
2
DIFF_FILTER
1
0.01 2
5
10
```

File format of control.dat (8/9)

Keyword	Content	Data type	Option	Default	Example
DECREASE_THRESHOLD	Threshold value for determining whether the objective function decreases. If the difference of the objective function of the current iteration and the previous iteration is less than the threshold value, the objective function is deemed to decrease.	Positive real value		0.001	DECREASE_THRESHOLD 0.001
STEP_LENGTH *1)	Initial damping factor	Positive real value		0.50	STEP_LENGTH 0.5 0.1 0.5 3 0.5 1.2
	Lower limit of damping factor	Positive real value		0.10	
	Upper limit of damping factor	Positive real value		1.00	
	Number of iteration for increasing damping factor	Positive integer		3	
	Factor for decreasing damping factor	Real value less than or equal to 1.0		0.50	
	Factor for increasing damping factor	Real value greater than or equal to 1.0		1.25	
RETRIAL	Maximum number of the decreasing of damping factor	Positive integer		5	RETRIAL 3

*1) Modification algorithm of the damping factor is shown as flow chart in the next slide.

File format of control.dat (9/9)

Keyword	Content	Data type	Option	Default	Example
APP_PHS_OPTION	Option about treatment of apparent resistivity and phase	Integer (0 or 1)	0:No special treatment 1:Impedance tensor is used instead of apparent resistivity and phase if the sign of the real part of impedance tensor component is different between observed and calculated responses. This treatment will improve the stabilization of the inversion using apparent resistivity and phase.	0	APP_PHS_OPTION 1
END	Indication of the end of controlling parameters				END

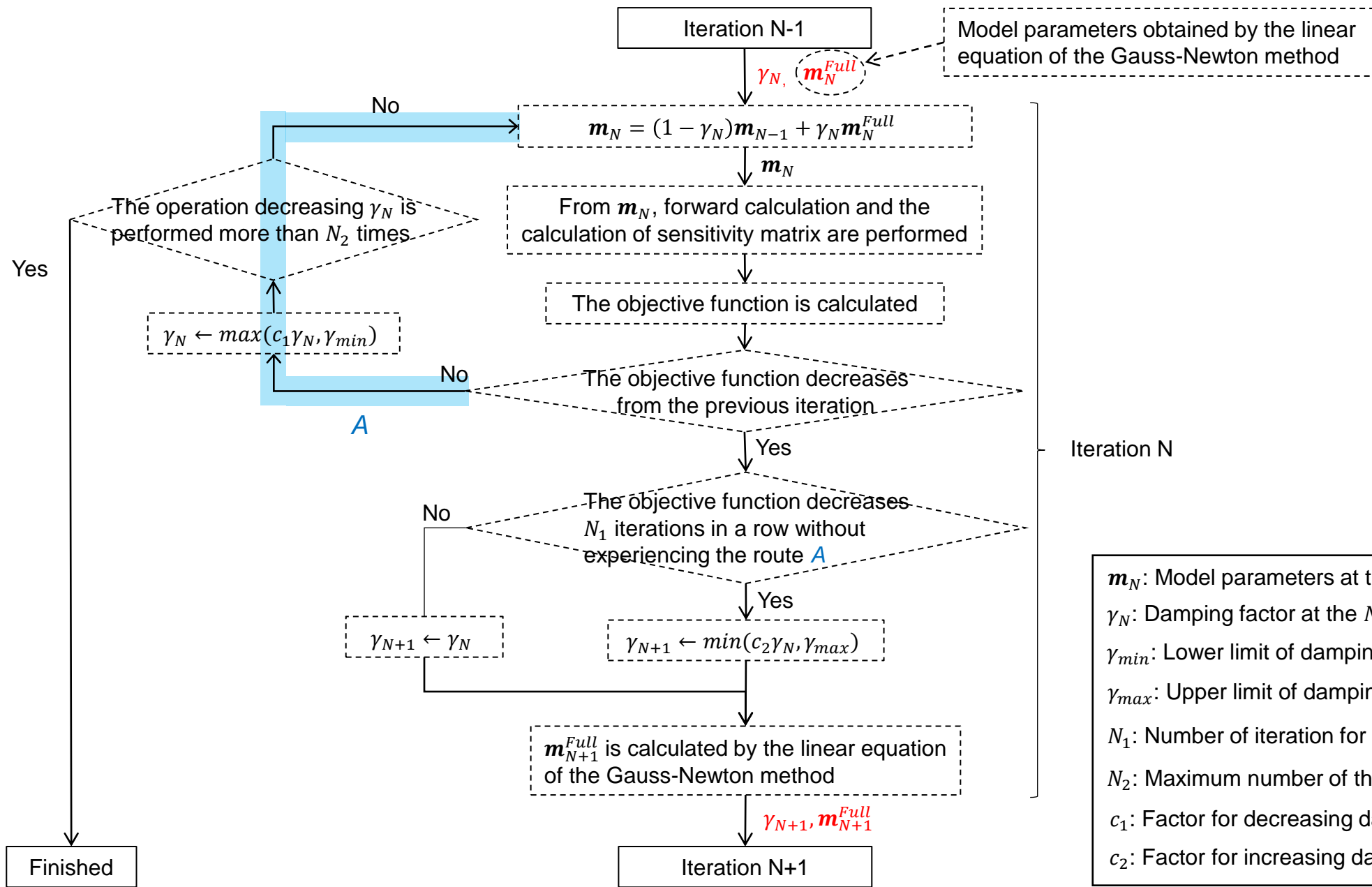

m_N : Model parameters at the N -th iteration
 γ_N : Damping factor at the N -th iteration
 γ_{min} : Lower limit of damping factor
 γ_{max} : Upper limit of damping factor
 N_1 : Number of iteration for increasing damping factor
 N_2 : Maximum number of the decreasing of damping factor
 c_1 : Factor for decreasing damping factor
 c_2 : Factor for increasing damping factor

File format of mesh.dat (for brick elements) (1/3)

HEXA

<i>Division number of the X direction (N_X)</i>	<i>Division number of the Y direction (N_Y)</i>	<i>Division number of the Z direction (N_Z)</i>	<i>Division number of the air layer (N_{Air})</i>
0	<i>X coordinate value of the 1st node</i>	<i>Y coordinate value of the 1st node</i>	<i>Z coordinate value of the 1st node</i>

⋮

$N_n - 1$	<i>X coordinate value of the N_n-th node</i>	<i>Y coordinate value of the N_n-th node</i>	<i>Z coordinate value of the N_n-th node</i>
-----------	---	---	---

*1) $N_n = (N_X + 1)(N_Y + 1)(N_Z + 1)$

Number of elements (N_e) *2) $N_e = N_X N_Y N_Z$

0	<i>Index of the adjacent element sharing face 0</i>	<i>Index of the adjacent element sharing face 1</i>	<i>Index of the adjacent element sharing face 2</i>	<i>Index of the adjacent element sharing face 3</i>		
	<i>Index of the adjacent element sharing face 4</i>	<i>Index of the adjacent element sharing face 5</i>	<i>Index of node 0</i>	<i>Index of node 1</i>	<i>Index of node 2</i>	<i>Index of node 3</i>
	<i>Index of node 4</i>	<i>Index of node 5</i>	<i>Index of node 6</i>	<i>Index of node 7</i>		

⋮

$N_e - 1$	<i>Index of the adjacent element sharing face 0</i>	<i>Index of the adjacent element sharing face 1</i>	<i>Index of the adjacent element sharing face 2</i>	<i>Index of the adjacent element sharing face 3</i>		
	<i>Index of the adjacent element sharing face 4</i>	<i>Index of the adjacent element sharing face 5</i>	<i>Index of node 0</i>	<i>Index of node 1</i>	<i>Index of node 2</i>	<i>Index of node 3</i>
	<i>Index of node 4</i>	<i>Index of node 5</i>	<i>Index of node 6</i>	<i>Index of node 7</i>		

File format of mesh.dat (for brick elements) (2/3)

Number of the element faces on the Y-Z plane (-X side) (N_{-YZ})

*Element index of the
1st element face*

*The 1st node index
of the element face*

*The 2nd node index
of the element face*

*The 3rd node index
of the element face*

*The 4th node index
of the element face*

⋮

*Element index of the
 N_{-YZ} -th element face*

*The 1st node index
of the element face*

*The 2nd node index
of the element face*

*The 3rd node index
of the element face*

*The 4th node index
of the element face*

Number of the element faces on the Y-Z plane (+X side) (N_{+YZ})

*Element index of the
1st element face*

*The 1st node index
of the element face*

*The 2nd node index
of the element face*

*The 3rd node index
of the element face*

*The 4th node index
of the element face*

⋮

*Element index of the
 N_{+YZ} -th element face*

*The 1st node index
of the element face*

*The 2nd node index
of the element face*

*The 3rd node index
of the element face*

*The 4th node index
of the element face*

Number of the element faces on the Z-X plane (-Y side) (N_{-ZX})

*Element index of the
1st element face*

*The 1st node index
of the element face*

*The 2nd node index
of the element face*

*The 3rd node index
of the element face*

*The 4th node index
of the element face*

⋮

*Element index of the
 N_{-ZX} -th element face*

*The 1st node index
of the element face*

*The 2nd node index
of the element face*

*The 3rd node index
of the element face*

*The 4th node index
of the element face*

File format of mesh.dat (for brick elements) (3/3)

Number of the element faces on the Z-X plane (-Y side) (N_{+ZX})

*Element index of the
1st element face*

*The 1st node index
of the element face*

*The 2nd node index
of the element face*

*The 3rd node index
of the element face*

*The 4-th node index
of the element face*

⋮

*Element index of the
 N_{+ZX} -th element face*

*The 1st node index
of the element face*

*The 2nd node index
of the element face*

*The 3rd node index
of the element face*

*The 4-th node index
of the element face*

Number of the element faces on the X-Y plane (-Z side) (N_{-XY})

*Element index of the
1st element face*

*The 1st node index
of the element face*

*The 2nd node index
of the element face*

*The 3rd node index
of the element face*

*The 4-th node index
of the element face*

⋮

*Element index of the
 N_{-XY} -th element face*

*The 1st node index
of the element face*

*The 2nd node index
of the element face*

*The 3rd node index
of the element face*

*The 4-th node index
of the element face*

Number of the element faces on the X-Y plane (+Z side) (N_{+XY})

*Element index of the
1st element face*

*The 1st node index
of the element face*

*The 2nd node index
of the element face*

*The 3rd node index
of the element face*

*The 4-th node index
of the element face*

⋮

*Element index of the
 N_{+XY} -th element face*

*The 1st node index
of the element face*

*The 2nd node index
of the element face*

*The 3rd node index
of the element face*

*The 4-th node index
of the element face*

File format of mesh.dat (for tetrahedral elements) (1/3)

TETRA			
Number of nodes (N_n)			
0	X coordinate value of the 1 st node	Y coordinate value of the 1 st node	Z coordinate value of the 1 st node
⋮			
$N_n - 1$	X coordinate value of the N_n -th node	Y coordinate value of the N_n -th node	Z coordinate value of the N_n -th node

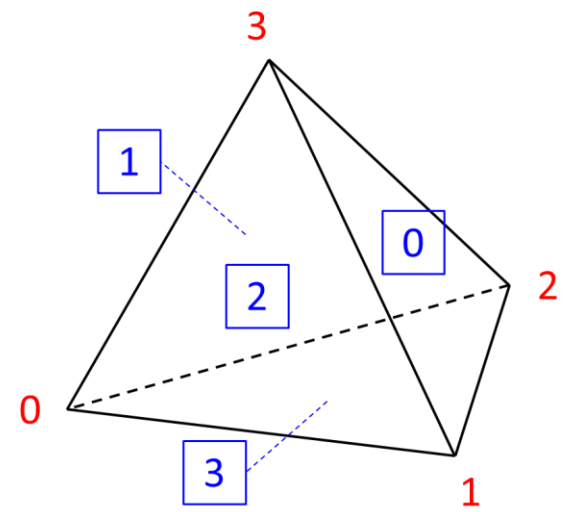

Number of elements (N_e)								
0	Index of the adjacent element sharing face 0		Index of the adjacent element sharing face 1		Index of the adjacent element sharing face 2		Index of the adjacent element sharing face 3	
	Index of node 0	Index of node 1	Index of node 2	Index of node 3				
⋮								
$N_e - 1$	Index of the adjacent element sharing face 0		Index of the adjacent element sharing face 1		Index of the adjacent element sharing face 2		Index of the adjacent element sharing face 3	
	Index of node 0	Index of node 1	Index of node 2	Index of node 3				

File format of mesh.dat (for tetrahedral elements) (2/3)

Number of the element faces on the Y-Z plane (-X side) (N_{-YZ})

Element index of the 1st element face

Face index of the 1st element face

⋮

Element index of the N_{-YZ} -th element face

Face index of the N_{-YZ} -th element face

Number of the element faces on the Y-Z plane (+X side) (N_{+YZ})

Element index of the 1st element face

Face index of the 1st element face

⋮

Element index of the N_{+YZ} -th element face

Face index of the N_{+YZ} -th element face

Number of the element faces on the Z-X plane (-Y side) (N_{-ZX})

Element index of the 1st element face

Face index of the 1st element face

⋮

Element index of the N_{-ZX} -th element face

Face index of the N_{-ZX} -th element face

Number of the element faces on the Z-X plane (+Y side) (N_{+ZX})

Element index of the 1st element face

Face index of the 1st element face

⋮

Element index of the N_{+ZX} -th element face

Face index of the N_{+ZX} -th element face

File format of mesh.dat (for tetrahedral elements) (3/3)

Number of the element faces on the X-Y plane (-Z side) (N_{-XY})

Element index of the 1st element face

Face index of the 1st element face

⋮

Element index of the N_{-XY} -th element face

Face index of the N_{-XY} -th element face

Number of the element faces on the X-Y plane (+Z side) (N_{+XY})

Element index of the 1st element face

Face index of the 1st element face

⋮

Element index of the N_{+XY} -th element face

Face index of the N_{+XY} -th element face

Number of the element faces on the earth's surface (N_{surf})

Element index of the 1st element face

Face index of the 1st element face

⋮

Element index of the N_{surf} -th element face

Face index of the N_{surf} -th element face

File format of mesh.dat (for deformed non-conforming hexahedral elements) (1/4)

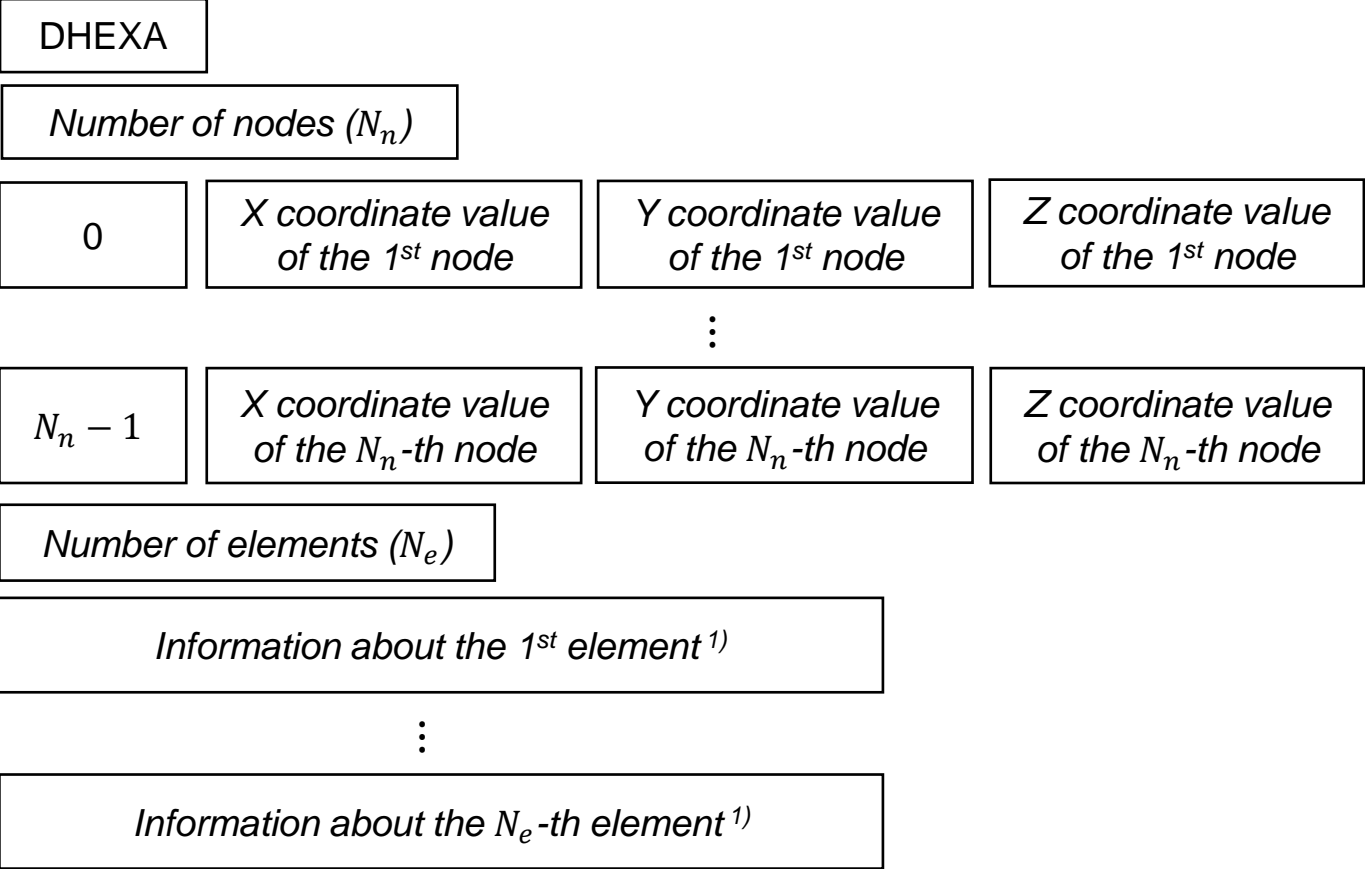

*1) The format of the information about element is described in the next slide

File format of mesh.dat (for deformed non-conforming hexahedral elements) (2/4)

The format of the information about element

Element Index	Index of node 0	Index of node 1	Index of node 2	Index of node 3	Index of node 4	Index of node 5	Index of node 6	Index of node 7
	Total number of the adjacent elements sharing face 0		The element index of the 1st adjacent element			...	The element index of the last adjacent element	
	Total number of the adjacent elements sharing face 1		The element index of the 1st adjacent element			...	The element index of the last adjacent element	
	Total number of the adjacent elements sharing face 2		The element index of the 1st adjacent element			...	The element index of the last adjacent element	
	Total number of the adjacent elements sharing face 3		The element index of the 1st adjacent element			...	The element index of the last adjacent element	
	Total number of the adjacent elements sharing face 4		The element index of the 1st adjacent element			...	The element index of the last adjacent element	
	Total number of the adjacent elements sharing face 5		The element index of the 1st adjacent element			...	The element index of the last adjacent element	

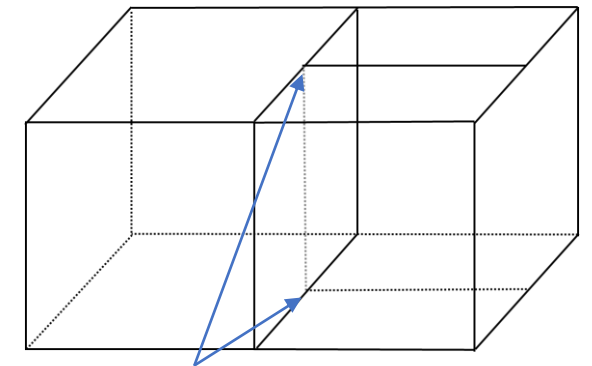
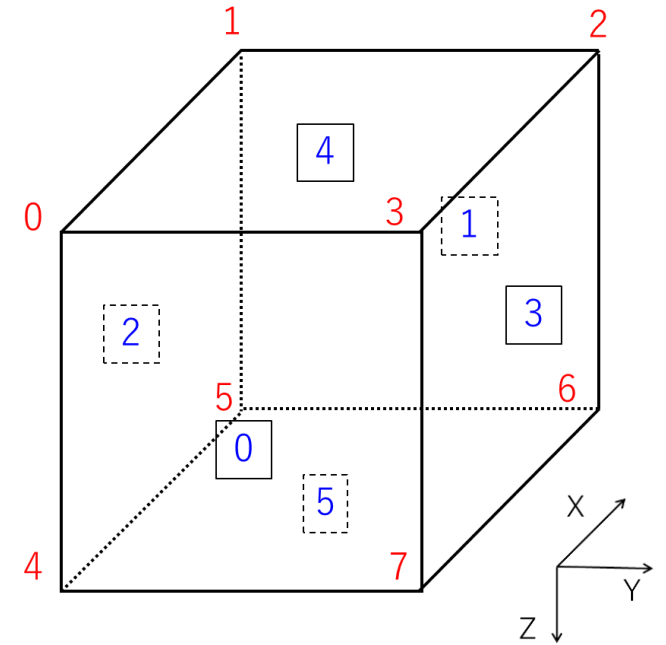

Hanging node

Total number of the adjacent elements is larger than 1 if there are hanging nodes on the face. If there is no adjacent element, that can occur at the outer boundary of the mesh, total number of the adjacent elements should be zero or a negative value.

File format of mesh.dat (for deformed non-conforming hexahedral elements) (3/4)

Number of the element faces on the Y-Z plane (-X side) (N_{-YZ})

Element index of the 1st element face

Face index of the 1st element face

⋮

Element index of the N_{-YZ} -th element face

Face index of the N_{-YZ} -th element face

Number of the element faces on the Y-Z plane (+X side) (N_{+YZ})

Element index of the 1st element face

Face index of the 1st element face

⋮

Element index of the N_{+YZ} -th element face

Face index of the N_{+YZ} -th element face

Number of the element faces on the Z-X plane (-Y side) (N_{-ZX})

Element index of the 1st element face

Face index of the 1st element face

⋮

Element index of the N_{-ZX} -th element face

Face index of the N_{-ZX} -th element face

Number of the element faces on the Z-X plane (+Y side) (N_{+ZX})

Element index of the 1st element face

Face index of the 1st element face

⋮

Element index of the N_{+ZX} -th element face

Face index of the N_{+ZX} -th element face

File format of mesh.dat (for deformed non-conforming hexahedral elements) (4/4)

Number of the element faces on the X-Y plane (-Z side) (N_{-XY})

Element index of the 1st element face

Face index of the 1st element face

⋮

Element index of the N_{-XY} -th element face

Face index of the N_{-XY} -th element face

Number of the element faces on the X-Y plane (+Z side) (N_{+XY})

Element index of the 1st element face

Face index of the 1st element face

⋮

Element index of the N_{+XY} -th element face

Face index of the N_{+XY} -th element face

Number of the element faces on the earth's surface (N_{surf})

Element index of the 1st element face

Face index of the 1st element face

⋮

Element index of the N_{surf} -th element face

Face index of the N_{surf} -th element face

resistivity_block_iter[lter#].dat

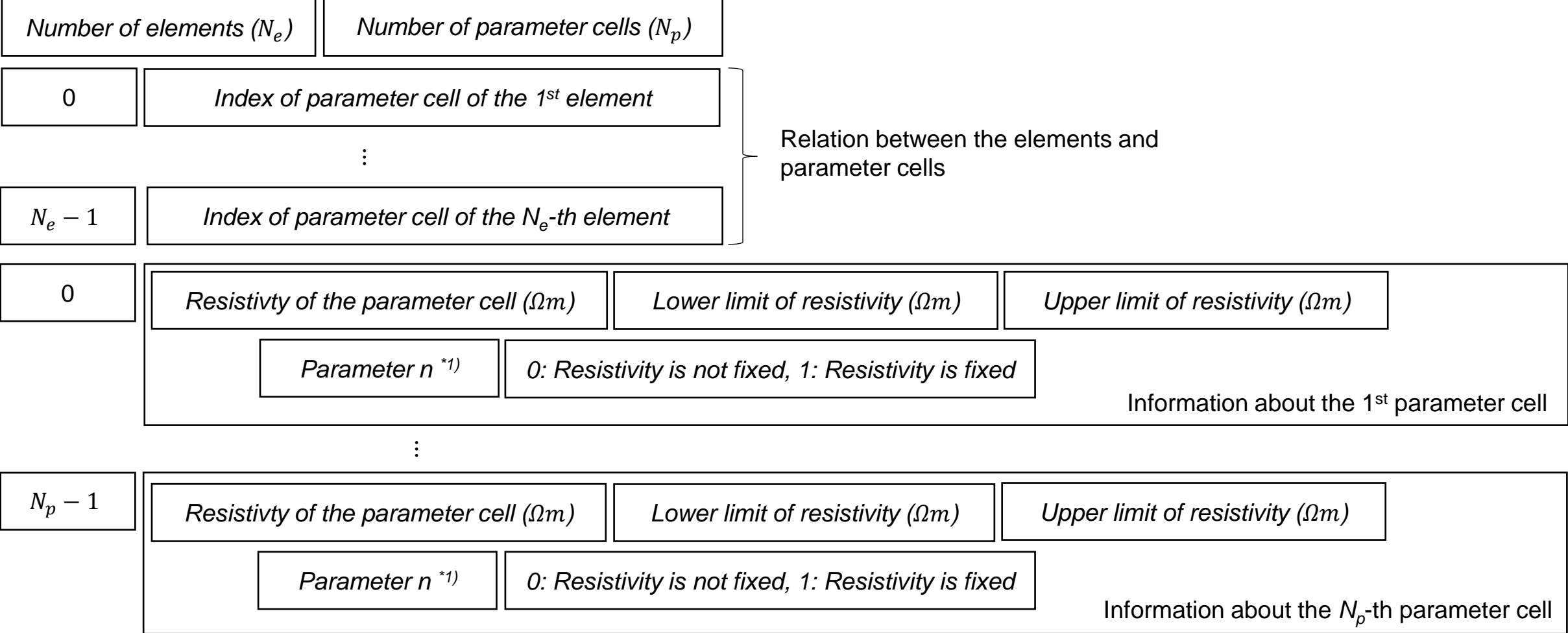

*1) Parameter n is used only if the option of the keyword 'RESISTIVITY_BOUNDS' of control.dat is 1.

File format of observe.dat

The following response functions can be used as the observed data.

Impedance tensor

$$\begin{pmatrix} E_x \\ E_y \end{pmatrix} = \begin{pmatrix} Z_{xx} & Z_{xy} \\ Z_{yx} & Z_{yy} \end{pmatrix} \begin{pmatrix} H_x \\ H_y \end{pmatrix}$$

Vertical magnetic transfer function (Tipper)

$$H_z = \begin{pmatrix} T_{zx} & T_{zy} \end{pmatrix} \begin{pmatrix} H_x \\ H_y \end{pmatrix}$$

Horizontal magnetic transfer function between two sites

$$\begin{pmatrix} H_x^{Site1} \\ H_y^{Site1} \end{pmatrix} = \begin{pmatrix} T_{xx} & T_{xy} \\ T_{yx} & T_{yy} \end{pmatrix} \begin{pmatrix} H_x^{Site2} \\ H_y^{Site2} \end{pmatrix}$$

Phase tensor (Caldwell et al. 2004)

$$\begin{pmatrix} \Phi_{11} & \Phi_{12} \\ \Phi_{21} & \Phi_{22} \end{pmatrix} = \begin{pmatrix} Re(Z_{xx}) & Re(Z_{xy}) \\ Re(Z_{yx}) & Re(Z_{yy}) \end{pmatrix}^{-1} \begin{pmatrix} Im(Z_{xx}) & Im(Z_{xy}) \\ Im(Z_{yx}) & Im(Z_{yy}) \end{pmatrix}$$

Apparent resistivity

$$\rho_{a,ij} = \frac{1}{\omega\mu_0} |Z_{ij}|^2$$

Phase

$$\theta_{ij} = \begin{cases} \text{Arctan}\left(\frac{Im(Z_{ij})}{Re(Z_{ij})}\right) & (Re(Z_{ij}) \geq 0) \\ \text{Arctan}\left(\frac{Im(Z_{ij})}{Re(Z_{ij})}\right) + \pi & (Re(Z_{ij}) < 0 \text{ and } Im(Z_{ij}) \geq 0) \\ \text{Arctan}\left(\frac{Im(Z_{ij})}{Re(Z_{ij})}\right) - \pi & (Re(Z_{ij}) < 0 \text{ and } Im(Z_{ij}) < 0) \end{cases}$$

Response functions must be written in SI units with $e^{-i\omega t}$ time dependence.

Impedance tensor (1/2)

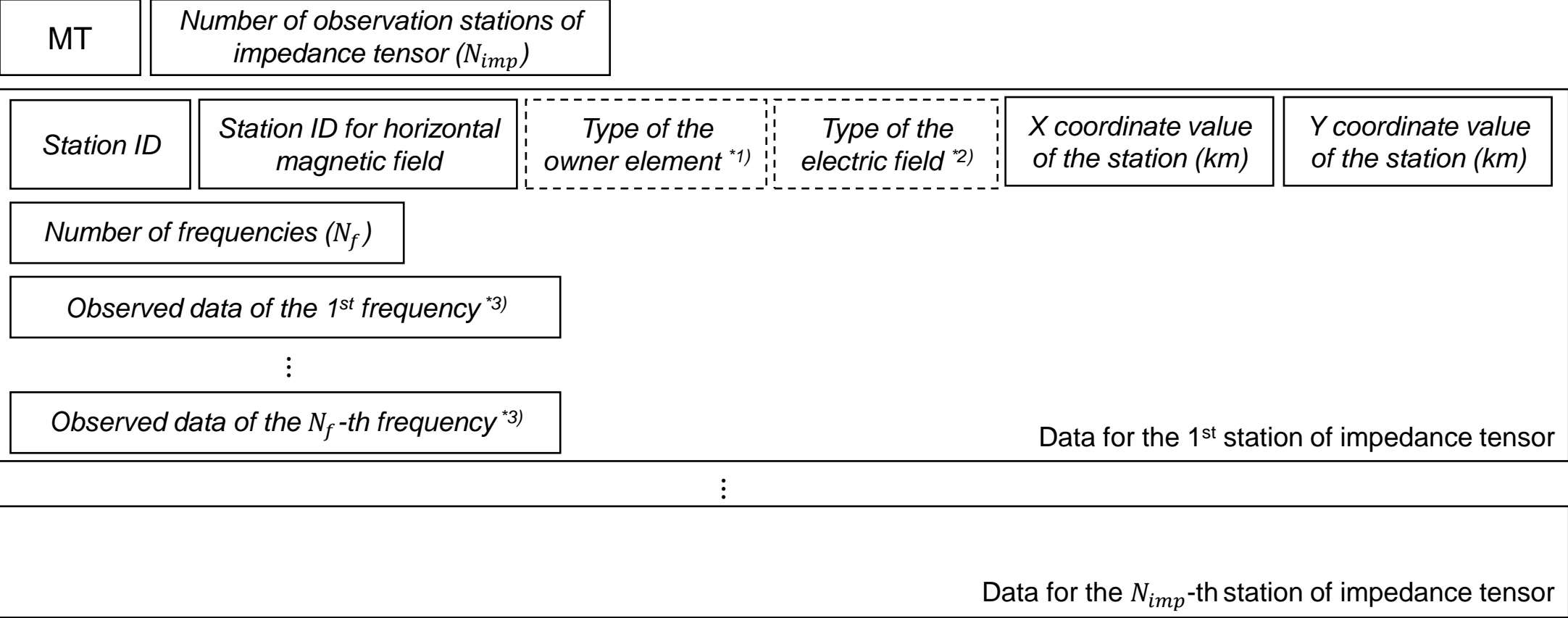

*1) Type of the owner element (0: Downward element, 1: Upward element) is needed only if the option of the keyword 'OWNER_ELEMENT' in 'control.dat' is -1.

*2) Type of the electric field (0: Horizontal electric field, 1: Tangential electric field) is needed only if the option of the keyword 'ELEC_FIELD' in 'control.dat' is -1.

*3) The format of the observed data of each frequency is described in the next slide

Impedance tensor (2/2)

The format of the observed data of each frequency

<i>Frequency(Hz)</i>	<i>Re(Z_{xx})</i> (V/A)	<i>Im(Z_{xx})</i> (V/A)	<i>Re(Z_{xy})</i> (V/A)	<i>Im(Z_{xy})</i> (V/A)	<i>Re(Z_{yx})</i> (V/A)	<i>Im(Z_{yx})</i> (V/A)	<i>Re(Z_{yy})</i> (V/A)	<i>Im(Z_{yy})</i> (V/A)
	<i>SD of Re(Z_{xx})</i>	<i>SD of Im(Z_{xx})</i>	<i>SD of Re(Z_{xy})</i>	<i>SD of Im(Z_{xy})</i>				
			<i>SD of Re(Z_{yx})</i>	<i>SD of Im(Z_{yx})</i>	<i>SD of Re(Z_{yy})</i>	<i>SD of Im(Z_{yy})</i>		

Apparent resistivity & phase (1/2)

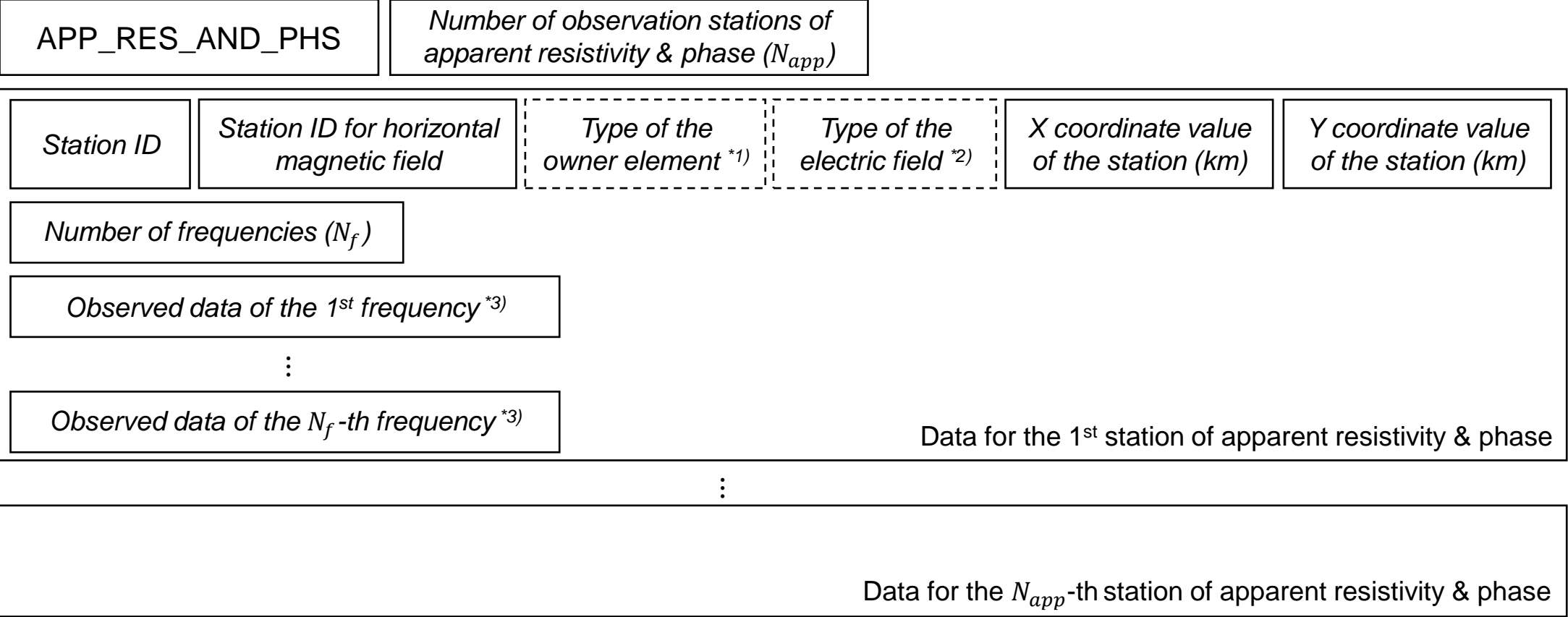

*1) Type of the owner element (0: Downward element, 1: Upward element) is needed only if the option of the keyword 'OWNER_ELEMENT' in 'control.dat' is -1.

*2) Type of the electric field (0: Horizontal electric field, 1: Tangential electric field) is needed only if the option of the keyword 'ELEC_FIELD' in 'control.dat' is -1.

*3) The format of the observed data of each frequency is described in the next slide

Apparent resistivity & phase (2/2)

The format of the observed data of each frequency

<i>Frequency(Hz)</i>	$\rho_{a,xx}$ (Ωm)	θ_{xx} (<i>deg.</i>)	$\rho_{a,xy}$ (Ωm)	θ_{xy} (<i>deg.</i>)	$\rho_{a,yx}$ (Ωm)	θ_{yx} (<i>deg.</i>)	$\rho_{a,yy}$ (Ωm)	θ_{yy} (<i>deg.</i>)
	<i>SD of $\rho_{a,xx}$</i>	<i>SD of θ_{xx}</i>	<i>SD of $\rho_{a,xy}$</i>	<i>SD of θ_{xy}</i>				
		<i>SD of $\rho_{a,yx}$</i>	<i>SD of θ_{yx}</i>	<i>SD of $\rho_{a,yy}$</i>	<i>SD of θ_{yy}</i>			

If SD is negative, the corresponding component is not used in the inversion.

Vertical magnetic transfer function (1/2)

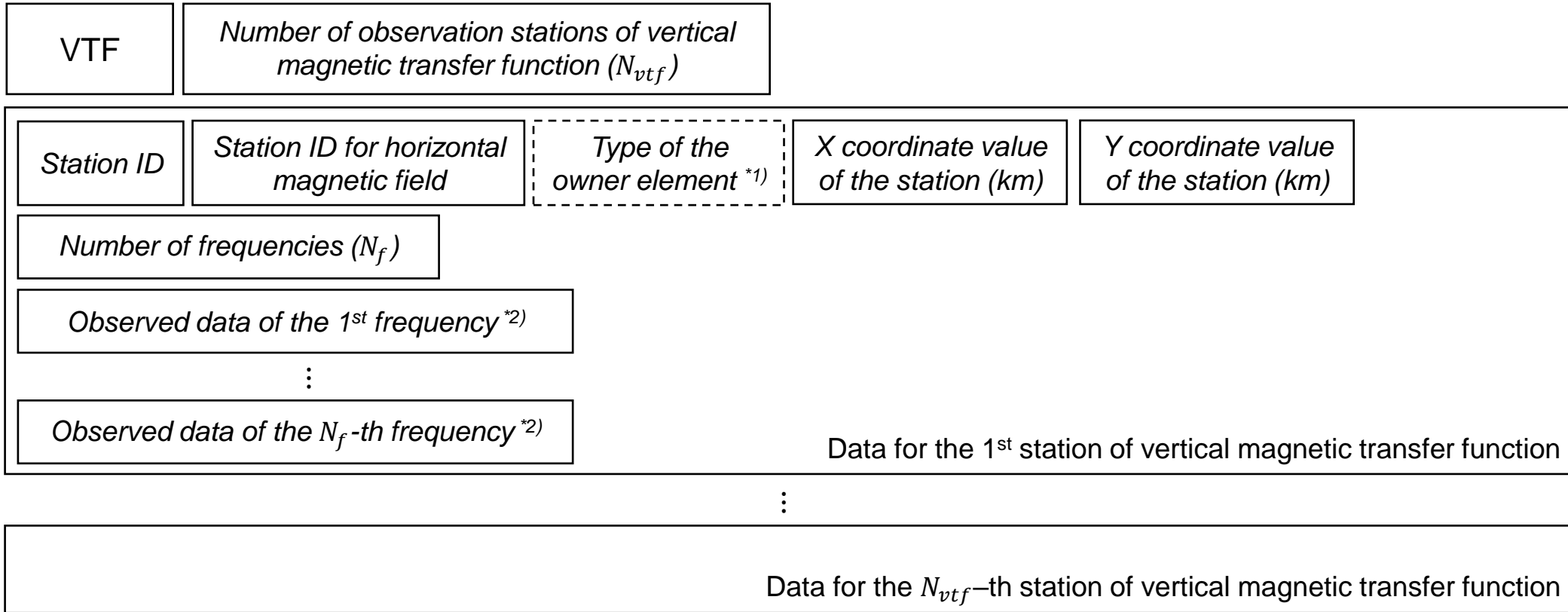

*1) Type of the owner element (0: Downward element, 1: Upward element) is needed only if the option of the keyword 'OWNER_ELEMENT' in 'control.dat' is -1.

*2) The format of the observed data of each frequency is described in the next slide

Vertical magnetic transfer function (2/2)

The format of the observed data of each frequency

<i>Frequency(Hz)</i>	<i>Re(T_{zx})</i>	<i>Im(T_{zx})</i>	<i>Re(T_{zy})</i>	<i>Im(T_{zy})</i>	<i>SD of Re(T_{zx})</i>	<i>SD of Im(T_{zx})</i>	<i>SD of Re(T_{zy})</i>	<i>SD of Im(T_{zy})</i>
----------------------	--------------------------------	--------------------------------	--------------------------------	--------------------------------	--------------------------------------	--------------------------------------	--------------------------------------	--------------------------------------

Horizontal magnetic transfer function (1/2)

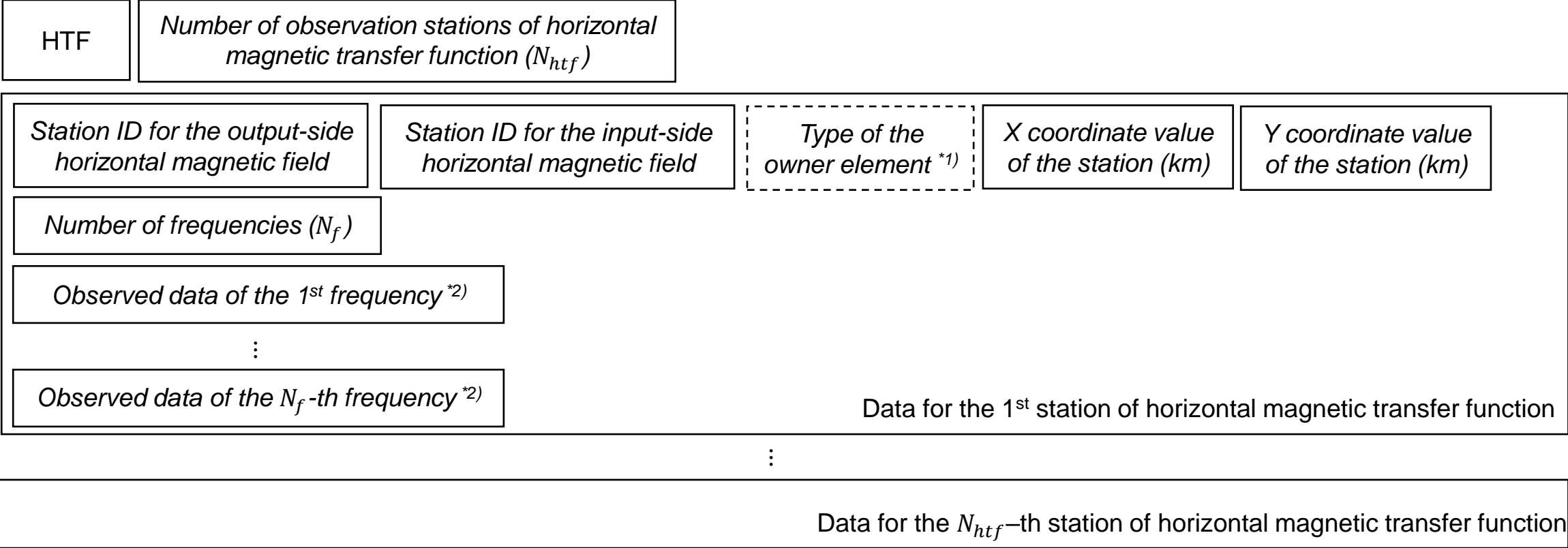

*1) Type of the owner element (0: Downward element, 1: Upward element) is needed only if the option of the keyword 'OWNER_ELEMENT' in 'control.dat' is -1.

*2) The format of the observed data of each frequency is described in the next slide

Horizontal magnetic transfer function(2/2)

The format of the observed data of each frequency

<i>Frequency(Hz)</i>	<i>Re(T_{xx})</i>	<i>Im(T_{xx})</i>	<i>Re(T_{xy})</i>	<i>Im(T_{xy})</i>	<i>Re(T_{yx})</i>	<i>Im(T_{yx})</i>	<i>Re(T_{yy})</i>	<i>Im(T_{yy})</i>
	<i>SD of $Re(T_{xx})$</i>	<i>SD of $Im(T_{xx})$</i>	<i>SD of $Re(T_{xy})$</i>	<i>SD of $Im(T_{xy})$</i>				
		<i>SD of $Re(T_{yx})$</i>	<i>SD of $Im(T_{yx})$</i>	<i>SD of $Re(T_{yy})$</i>	<i>SD of $Im(T_{yy})$</i>			

Phase tensor (1/2)

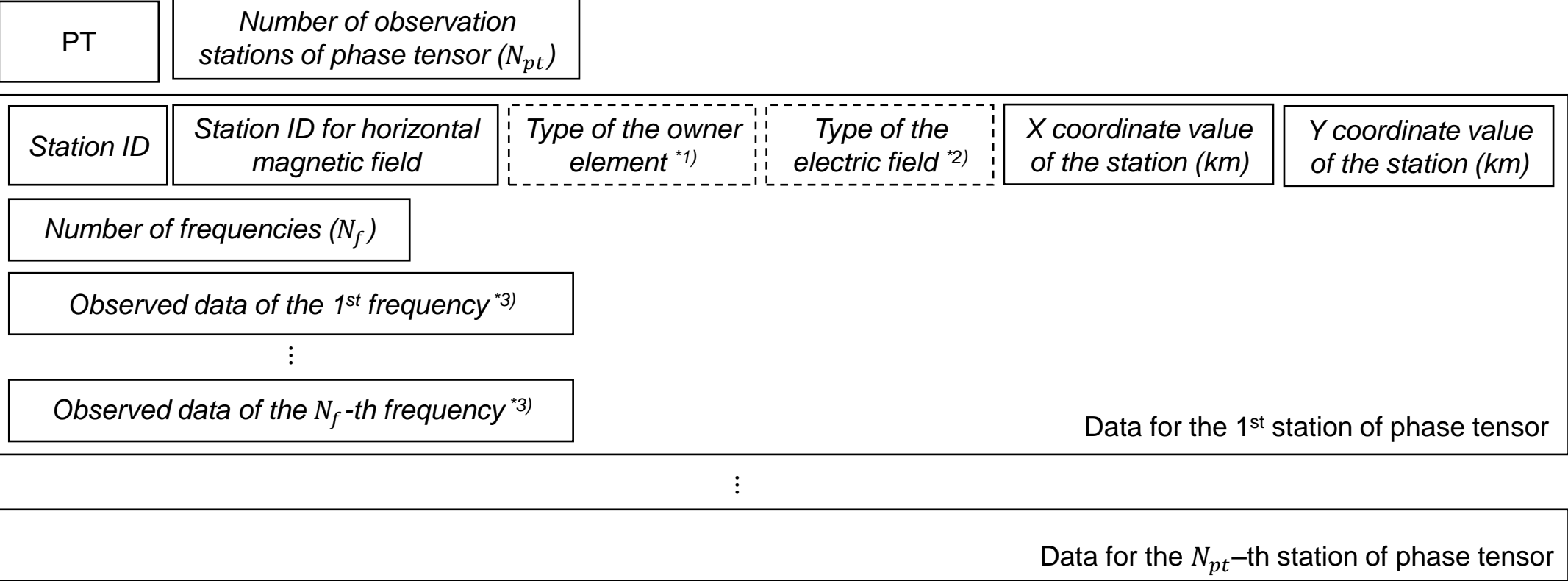

*1) Type of the owner element (0: Downward element, 1: Upward element) is needed only if the option of the keyword 'OWNER_ELEMENT' in 'control.dat' is -1.

*2) Type of the electric field (0: Horizontal electric field, 1: Tangential electric field) is needed only if the option of the keyword 'ELEC_FIELD' in 'control.dat' is -1.

*3) The format of the observed data of each frequency is described in the next slide

Phase tensor (2/2)

The format of the observed data of each frequency

<i>Frequency(Hz)</i>	Φ_{11}	Φ_{12}	Φ_{21}	Φ_{22}	<i>SD of Re(Φ_{11})</i>	<i>SD of Im(Φ_{12})</i>	<i>SD of Re(Φ_{21})</i>	<i>SD of Im(Φ_{22})</i>
----------------------	-------------	-------------	-------------	-------------	---	---	---	---

Indication of the end of observation data

Observation data of impedance tensor

Observation data of apparent resistivity & phase

Observation data of vertical magnetic transfer function

Observation data of horizontal magnetic transfer function

Observation data of phase tensor

END

← Keyword 'END' must be written at the end of observation data

File format of distortion_iter[Iter#].dat (1/3)

When keyword 'DISTORTION' is 1 (differences of distortion matrix and unit matrix are estimated),

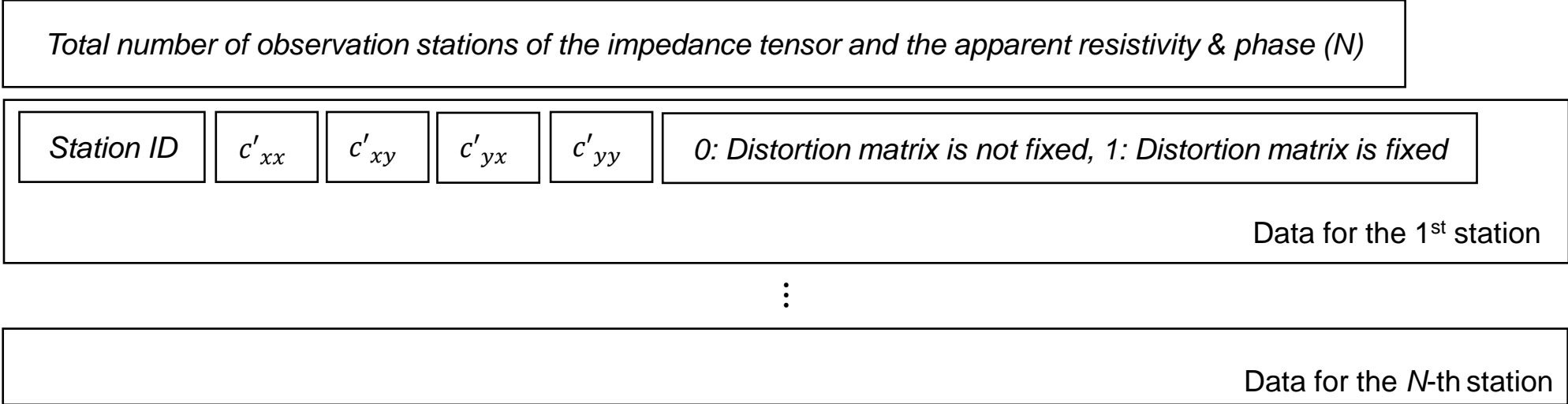

Distortion matrix: $\mathbf{Z}_{observed} = \begin{pmatrix} c_{xx} & c_{xy} \\ c_{yx} & c_{yy} \end{pmatrix} \mathbf{Z}_{regional}$

$$\begin{pmatrix} c'_{xx} & c'_{xy} \\ c'_{yx} & c'_{yy} \end{pmatrix} = \begin{pmatrix} c_{xx} & c_{xy} \\ c_{yx} & c_{yy} \end{pmatrix} - \begin{pmatrix} 1 & 0 \\ 0 & 1 \end{pmatrix} \in \mathbb{R}^{2 \times 2}$$

 Model parameters

File format of distortion_iter[Iter#].dat (2/3)

When keyword 'DISTORTION' is 2 (both gains and rotations are estimated),

Total number of observation stations of the impedance tensor and the apparent resistivity & phase (N)

Station ID

G_x

G_y

$\beta_x(deg.)$

$\beta_y(deg.)$

0: Distortion matrix is not fixed, 1: Distortion matrix is fixed

Data for the 1st station

⋮

Data for the N-th station

Distortion matrix is decomposed as Smith (1995)

$$\text{Distortion matrix: } \mathbf{Z}_{observed} = \left(10^{G_x} \begin{pmatrix} \cos\beta_x \\ \sin\beta_x \end{pmatrix} \quad 10^{G_y} \begin{pmatrix} -\sin\beta_y \\ \cos\beta_y \end{pmatrix} \right) \mathbf{Z}_{regional}$$

Smith, J. T. (1995). Understanding telluric distortion matrices. *Geophysical Journal International*, 122(1), 219–226. <https://doi.org/10.1111/j.1365-246X.1995.tb03549.x>

File format of distortion_iter[Iter#].dat (3/3)

When keyword 'DISTORTION' is 3 (only gains are only estimated),

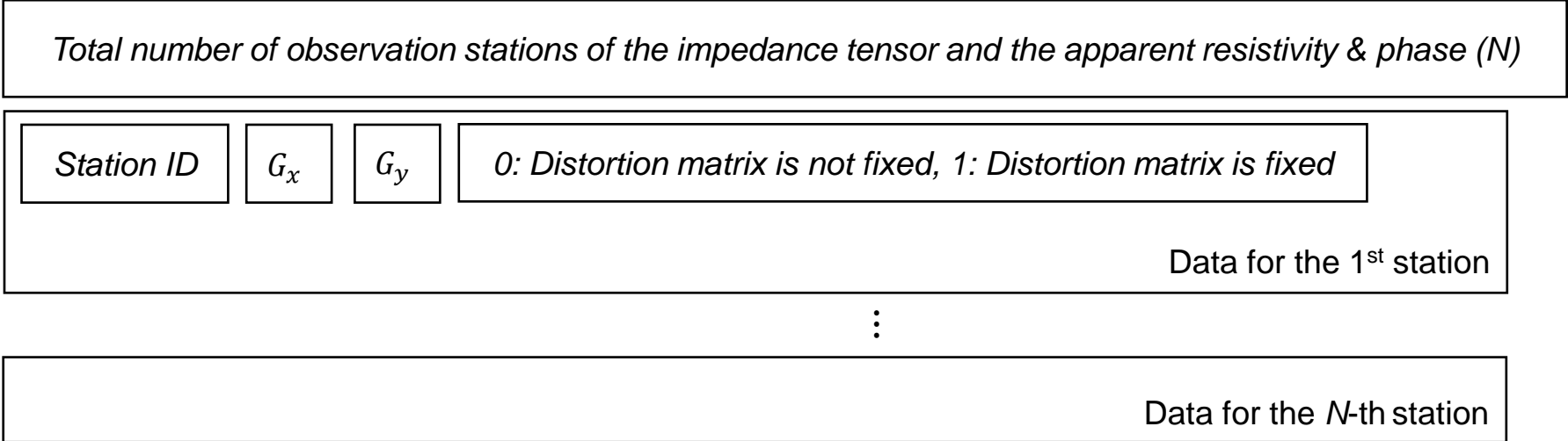

Distortion matrix: $\mathbf{Z}_{observed} = \begin{pmatrix} 10^{G_x} & 0 \\ 0 & 10^{G_y} \end{pmatrix} \mathbf{Z}_{regional}$

Output files

File name	Content
femtic_[PE#].log	Log information about calculation
femtic.cnv	Convergence of Gauss-Newton iteration
result_[PE#]_iter[Iter#].csv	Calculated response functions and observed response functions
resistivity_block_iter[Iter#].dat	Resistivity values obtained by the inversion
distortion_iter[Iter#].dat	Parameters of galvanic distortion obtained by the inversion

In the file names, [PE#] and [Iter#] indicate process number and iteration number, respectively.

Output files for the visualization with ParaView (1/4)

These output files can be read and visualized by ParaView (<http://www.paraview.org/>).

File name	Content
obs_loc.vtk	Locations of the observation stations used in the inversion
induction_arrow_[PE#]_iter[Iter#].vtk	Induction vector (Parkinson convention) at each station of the vertical magnetic transfer function
result.case	EnSight Gold case file
Mesh.geo	EnSight Gold geometry file
BlockIDs	IDs of parameter cells (EnSight Gold variable file format)
Resistivity.iter[Iter#]	Resistivity values (EnSight Gold variable file format)
ReE_Freq[Freq#]_ExPol.iter[Iter#]	Real part of the electric field for the Ex-polarization (EnSight Gold variable file format)
ImE_Freq[Freq#]_ExPol.iter[Iter#]	Imaginary part of the electric field for the Ex-polarization (EnSight Gold variable file format)

*1) In the file names, [PE#] and [Iter#] indicate process number and iteration number, respectively.

Output files for the visualization with ParaView (2/4)

These output files can be read and visualized by ParaView (<http://www.paraview.org/>).

File name	Content
ReE_Freq[Freq#]_EyPol.iter[Iter#]	Real part of the electric field for the Ey-polarization (EnSight Gold variable file format)
ImE_Freq[Freq#]_EyPol.iter[Iter#]	Imaginary part of the electric field for the Ey-polarization (EnSight Gold variable file format)
ReH_Freq[Freq#]_ExPol.iter[Iter#]	Real part of the magnetic field for the Ex-polarization (EnSight Gold variable file format)
ImH_Freq[Freq#]_ExPol.iter[Iter#]	Imaginary part of the magnetic field for the Ex-polarization (EnSight Gold variable file format)
ReH_Freq[Freq#]_EyPol.iter[Iter#]	Real part of the magnetic field for the Ey-polarization (EnSight Gold variable file format)
ImH_Freq[Freq#]_EyPol.iter[Iter#]	Imaginary part of the magnetic field for the Ey-polarization (EnSight Gold variable file format)
Rej_Freq[Freq#]_ExPol.iter[Iter#]	Real part of the electric current density for the Ex-polarization (EnSight Gold variable file format)

*1) In the file names, [PE#] and [Iter#] indicate process number and iteration number, respectively.

Output files for the visualization with ParaView (3/4)

These output files can be read and visualized by ParaView (<http://www.paraview.org/>).

File name	Content
Imj_Freq[Freq#]_ExPol.iter[Iter#]	Imaginary part of the electric current density for the Ex-polarization (EnSight Gold variable file format)
Rej_Freq[Freq#]_EyPol.iter[Iter#]	Real part of the electric current density for the Ey-polarization (EnSight Gold variable file format)
Imj_Freq[Freq#]_EyPol.iter[Iter#]	Imaginary part of the electric current density for the Ey-polarization (EnSight Gold variable file format)
Sensitivity.iter[Iter#]	Sensitivity (EnSight Gold variable file format) calculated as $s_i = \sum_j^{N_d} \left \frac{1}{\sigma_j} \frac{\partial d_j}{\partial \log(\rho_i)} \right $ <p>N_d : Number of the observation data *2) d_j : The j-th data σ_j : Standard deviation of the j-th data ρ_i : Resistivity at the i-th parameter cell</p>
NormalizedSensitivity.iter[Iter#]	Normalized sensitivity (EnSight Gold variable file format) calculated as $\bar{s}_i = s_i / \max_i s_i$

*1) In the file names, [PE#] and [Iter#] indicate process number and iteration number, respectively.

*2) Real part and imaginary part of each response function are treated as different data.

Output files for the visualization with ParaView (4/4)

These output files can be read and visualized by ParaView (<http://www.paraview.org/>).

File name	Content
SensitivityDensity.iter[Iter#]	Sensitivity density (EnSight Gold variable file format) calculated as $s'_i = \frac{1}{V_i} \sum_j^{N_d} \left \frac{1}{\sigma_j} \frac{\partial d_j}{\partial \log(\rho_i)} \right $ <p>N_d : Number of the observation data *2) d_j : The j-th data σ_j : Standard deviation of the j-th data ρ_i : Resistivity at the i-th parameter cell V_i : Volume of the i-th parameter cell</p>
NormalizedSensitivityDensity.iter[Iter#]	Normalized sensitivity (EnSight Gold variable file format) calculated as $\overline{s'_i} = s'_i / \max_i s'_i$
result_[PE#]_iter[Iter#].vtk	Output variables specified in 'OUTPUT_PARAM' (VTK file format (ASCII))

*1) In the file names, [PE#] and [Iter#] indicate process number and iteration number, respectively.

*2) Real part and imaginary part of each response function are treated as different data.

Things to be careful when seafloor MT data is used

- For seafloor MT stations, it is better to interpolate the electric field and the magnetic field from the upper-side and lower-side elements, respectively (Usui et al., 2018).
- However, the use of different elements for interpolating the electric field and the magnetic field needs a bit tricky setting.
- The required setting is as follows.

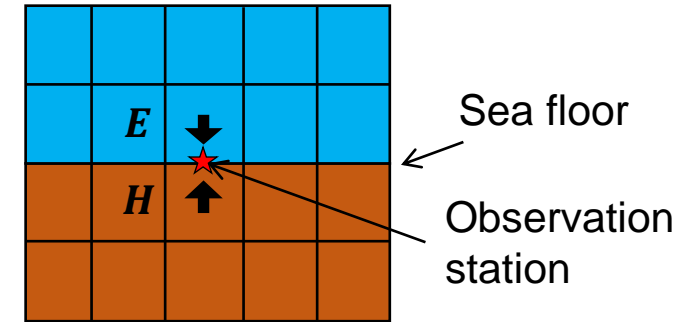

1. Set the option of the keyword 'OWNER_ELEMENT' of 'control.dat' to -1. By this setting, type of owner element can be individually selected for each element.
2. In 'observe.dat', add the dummy stations of the vertical magnetic transfer function or the horizontal magnetic transfer function at the same locations as seafloor MT stations. (If actually there are stations of the vertical magnetic transfer function or the horizontal magnetic transfer function on the same locations as the MT stations, you need not to add new dummy stations.)
3. For the dummy stations of magnetic transfer functions in 'observe.dat', set 'Type of the owner element' to 0 (element just below the seafloor is used for calculating the magnetic field)
4. For the seafloor MT stations in 'observe.dat', set 'Type of the owner element' to 1 (element just above the seafloor is used for calculating the electric field) and set 'Station ID for horizontal magnetic field' to the ID of the dummy station at the same location.

Things to be careful when seafloor MT data is used: Example

```
MT 2
1 1001 1 1.020000E+00 2.005000E+00
12
[Observed data of the 1st frequency]
...
[Observed data of the 12-th frequency]
2 1002 1 1.003330E+01 -9.004900E+01
12
[Observed data of the 1st frequency]
...
[Observed data of the 12-th frequency]
```

```
VTF 2
1001 1001 0 1.020000E+00 2.005000E+00
0
1002 1002 0 1.003330E+01 -9.004900E+01
0
```

} Dummy stations

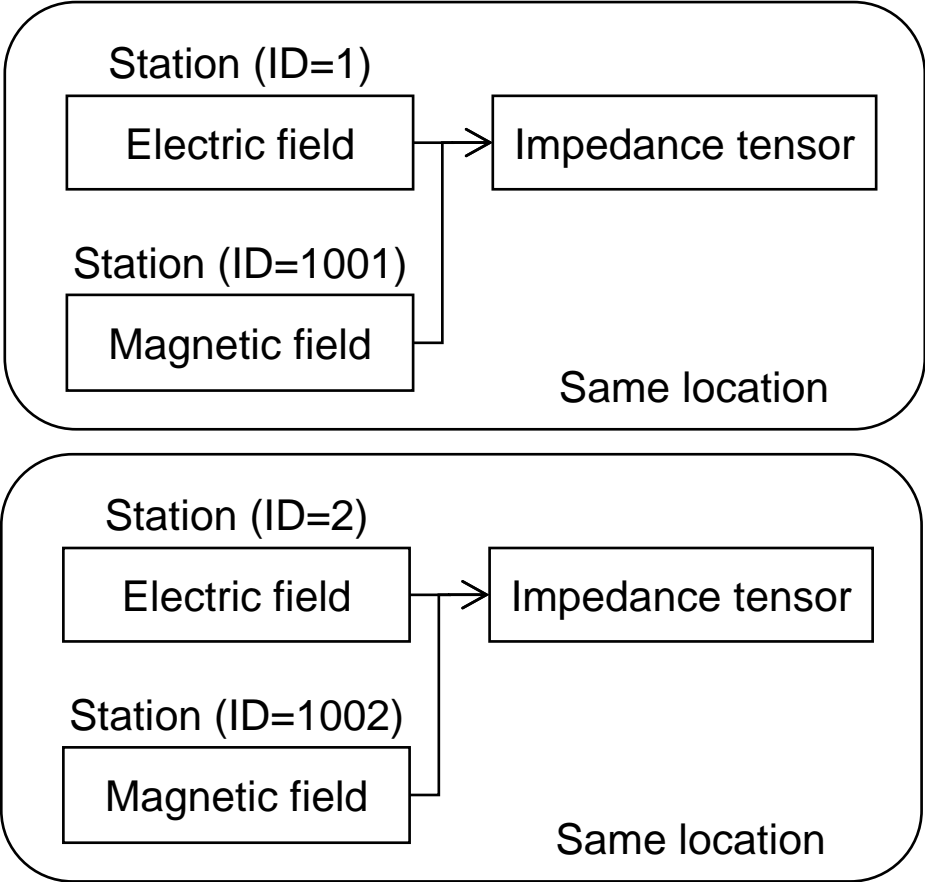

How to improve response functions at high frequencies

- For land MT stations, it is better to interpolate the electric field and the magnetic field from the lower-side and upper-side elements, respectively.
- This is because the change of the magnetic field is smaller in the upper-side (in the air).
- Otherwise, it is possible that the amplitude of the impedance tensor is overestimated unless the size of the element just below MT station is not sufficiently small.
- The recommended setting is as follows.

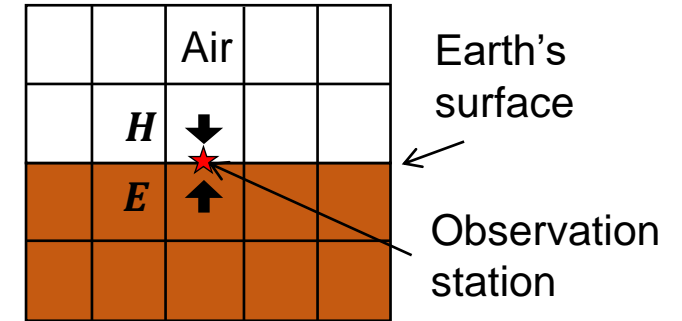

1. Set the option of the keyword 'OWNER_ELEMENT' of 'control.dat' to -1. By this setting, type of owner element can be individually selected for each element.
2. In 'observe.dat', add the dummy stations of the vertical magnetic transfer function or the horizontal magnetic transfer function at the same locations as land MT stations. (If actually there are stations of the vertical magnetic transfer function or the horizontal magnetic transfer function on the same locations as the MT stations, you need not to add new dummy stations.)
3. For the dummy stations of magnetic transfer functions in 'observe.dat', set 'Type of the owner element' to 1 (element just above the Earth's surface is used for calculating the magnetic field)
4. For the land MT stations in 'observe.dat', set 'Type of the owner element' to 0 (element just below the Earth's surface is used for calculating the electric field) and set 'Station ID for horizontal magnetic field' to the ID of the dummy station at the same location.

How to improve response functions at high frequencies: Example

```
MT 2
1 1001 0 1.020000E+00 2.005000E+00
12
[Observed data of the 1st frequency]
...
[Observed data of the 12-th frequency]
2 1002 0 1.003330E+01 -9.004900E+01
12
[Observed data of the 1st frequency]
...
[Observed data of the 12-th frequency]
```

```
VTF 2
1001 1001 1 1.020000E+00 2.005000E+00
0
1002 1002 1 1.003330E+01 -9.004900E+01
0
```

} Dummy stations

